

Silicon Power Schottky Diode

$V_{RRM} = 20\text{ V} - 40\text{ V}$

$I_{F(AV)} = 80\text{ A}$

Features

- High Surge Capability
- Types from 20 V to 40 V V_{RRM}
- Not ESD Sensitive

Note:

1. Standard polarity: Stud is cathode.
2. Reverse polarity (R): Stud is anode.
3. Stud is base.

DO-5 Package

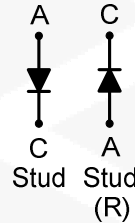

Maximum ratings, at $T_j = 25\text{ }^\circ\text{C}$, unless otherwise specified ("R" devices have leads reversed)

Parameter	Symbol	Conditions	MBR8020(R)	MBR8030(R)	MBR8035(R)	MBR8040(R)	Unit
Repetitive peak reverse voltage	V_{RRM}		20	30	35	40	V
RMS reverse voltage	V_{RMS}		14	21	25	28	V
DC blocking voltage	V_{DC}		20	30	35	40	V
Operating temperature	T_j		-55 to 150	-55 to 150	-55 to 150	-55 to 150	$^\circ\text{C}$
Storage temperature	T_{stg}		-55 to 150	-55 to 150	-55 to 150	-55 to 150	$^\circ\text{C}$

Electrical characteristics, at $T_j = 25\text{ }^\circ\text{C}$, unless otherwise specified

Parameter	Symbol	Conditions	MBR8020(R)	MBR8030(R)	MBR8035(R)	MBR8040(R)	Unit
Average forward current (per pkg)	$I_{F(AV)}$	$T_C = 125\text{ }^\circ\text{C}$	80	80	80	80	A
Peak forward surge current (per leg)	I_{FSM}	$t_p = 8.3\text{ ms}$, half sine	1000	1000	1000	1000	A
Maximum forward voltage (per leg)	V_F	$I_{FM} = 80\text{ A}$, $T_j = 25\text{ }^\circ\text{C}$	0.75	0.75	0.75	0.75	V
Maximum instantaneous reverse current at rated DC blocking voltage (per leg)	I_R	$T_j = 25\text{ }^\circ\text{C}$	1	1	1	1	mA
		$T_j = 100\text{ }^\circ\text{C}$	10	10	10	10	
		$T_j = 150\text{ }^\circ\text{C}$	20	20	20	20	

Thermal characteristics

Thermal resistance, junction-case (per leg)	$R_{\theta JC}$		0.50	0.50	0.50	0.50	$^\circ\text{C/W}$
Mounting torque			30	30	30	30	Inch ponds (in-pb)

Figure .1- Typical Forward Characteristics

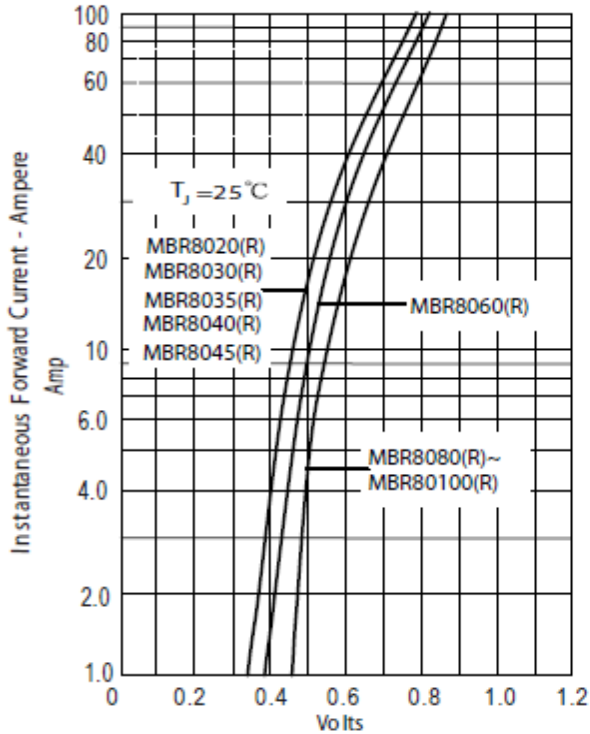

Instantaneous Forward Voltage - Volts

Figure .2- Forward Derating Curve

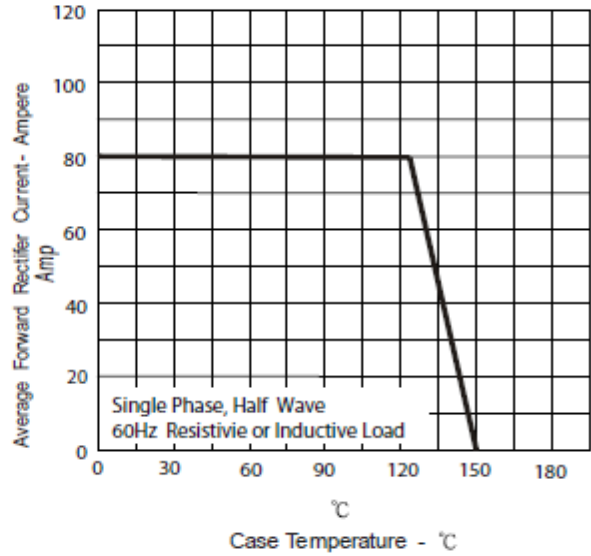

Figure .3- Peak Forward Surge Current

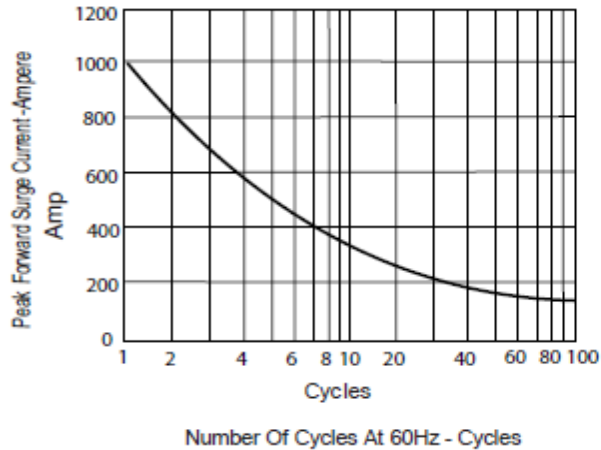
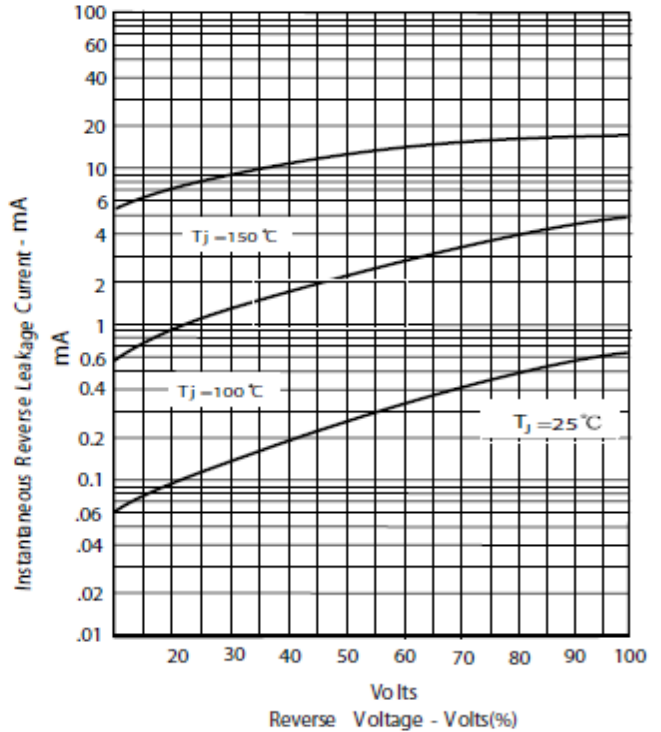
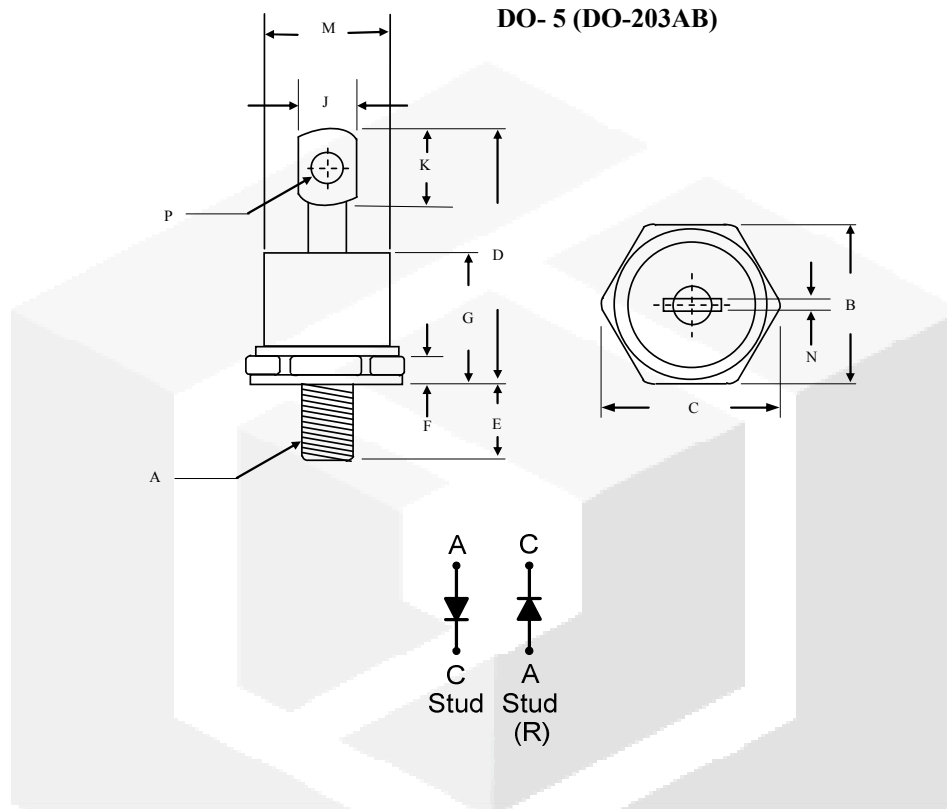

Figure .4- Typical Reverse Characteristics



Package dimensions and terminal configuration

Product is marked with part number and terminal configuration.



	Inches		Millimeters	
	Min	Max	Min	Max
A	1/4-28 UNF			
B	0.669	0.687	17.19	17.44
C	----	0.794	----	20.16
D	----	1.020	----	25.91
E	0.422	0.453	10.72	11.50
F	0.115	0.200	2.93	5.08
G	----	0.460	----	11.68
J	----	0.280	----	7.00
K	0.236	----	6.00	----
M	----	0.589	----	14.96
N	----	0.063	----	1.60
P	0.140	0.175	3.56	4.45